

sotkon
waste systems

.en
**Simple and
efficient.**



System

APTO



System APTO

The Apto system features a metal container for waste collection by top loading using a crane installed on a collection truck. It has a unitary concrete bunker, the collection containers are made of galvanized steel and the waste is received through intake columns located on the surface. The pedestrian platform, the intake columns and the container are stationary and their movement is carried out jointly by the truck's crane.

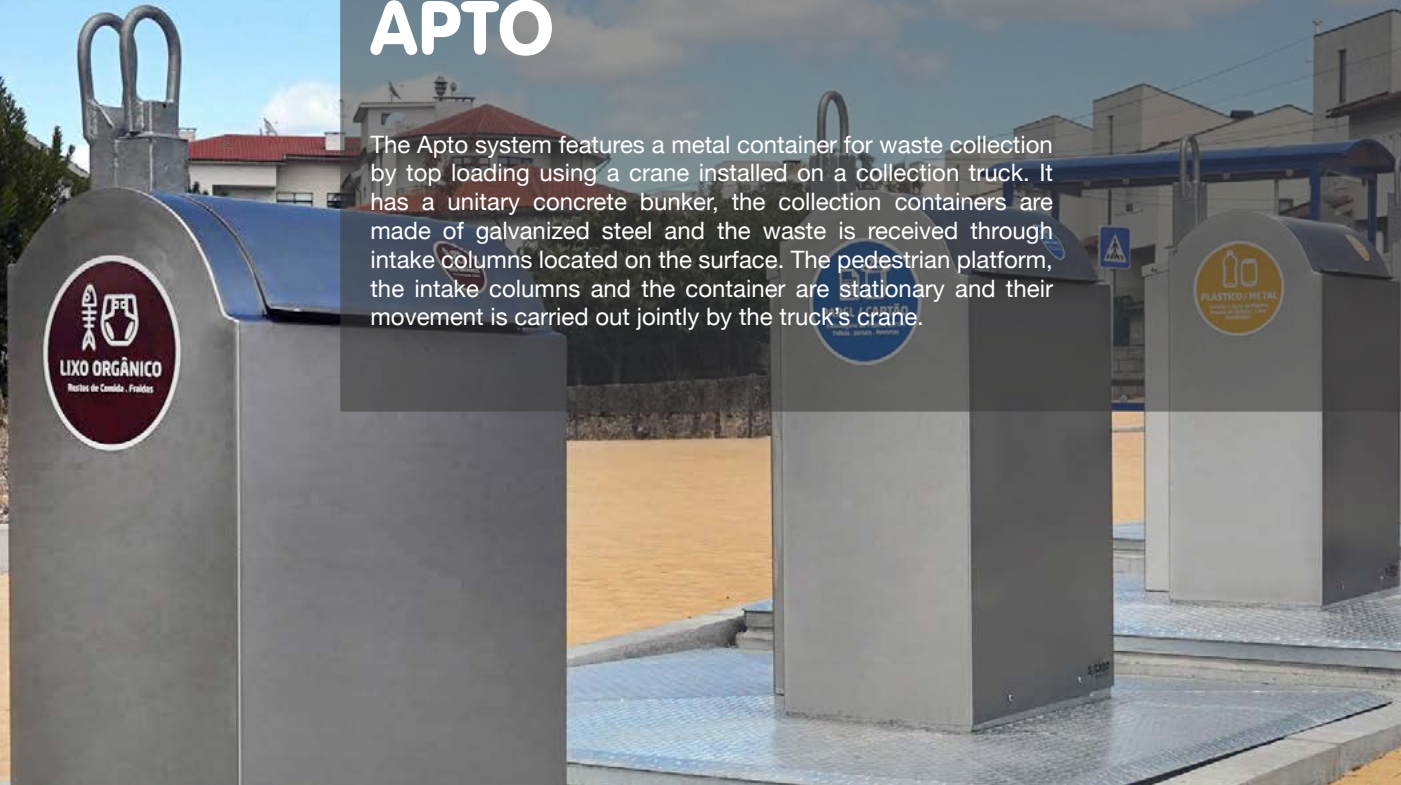

Automatic Collection

An Apto container can be picked up by top loading trucks with a crane equipped with Kinshofer or bilateral automatic pickup systems. A faster and more automatic collection operated safely.

Fewer Resources

Ease of operation, combined with the possibility of carrying out the collection process with a single worker, contributes to the use of fewer resources.

Higher Resistance

The superior strength of this type of construction makes this equipment more resistant to impacts and fire.

Fast Payback

The Apto system offers a fast return on investment (ROI) compared to surface container collection systems.

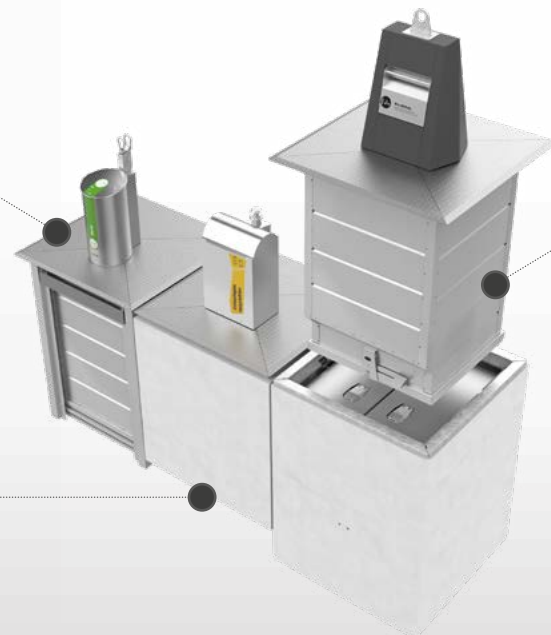
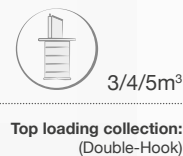

Intake Columns

Manufactured mostly in stainless steel to preserve exterior appearance and strength in harsh environments, they are designed keeping in mind ergonomics, ease of use and safety.

** Other finishes and solutions on request.*

Container

The containers, due to the way they were designed, have a superior mechanical resistance. They are manufactured in galvanized steel sheet using cutting, bending and riveting technologies. The bottom consists of one or two doors with leachate retention basins. Depending on the crane's lifting and loading system, the container is adapted with appropriate hardware and hooks.

- .Double-Hook
3/4/5 m³
- ."Mushroom"
3/4/5 m³
- .Palpeur
3/4/5m³
- .Single Hook
3/4/5m³
- .F90 Hook
3/4/5m³

Concrete Bunker

The unitary concrete bunker allows the container to be placed individually and can have various installation configurations. The composition of the materials used in the construction of the tank prevents the entry of water, which allows the installation of these containers in areas with higher phreatic levels.

Pedestrian Platform

The pedestrian platform is made of steel sheet, properly treated against corrosion with hot-dip galvanizing treatment.

Pedestrian Platform

.Surface finishing

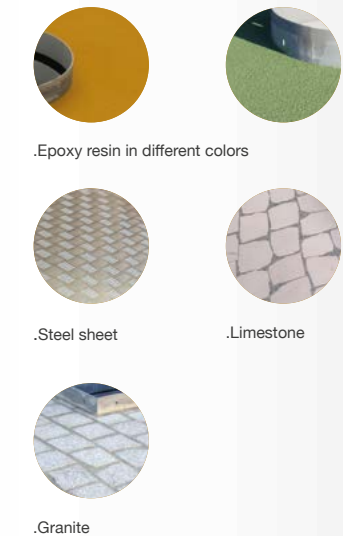

** Other finishes and solutions on request.*

Safety Platform

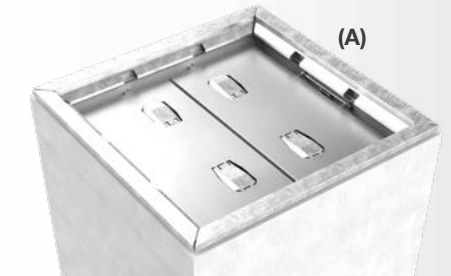

When the container is removed from inside the bunker the safety platform automatically rises, covering the opening completely. Two types of safety platforms can be installed:

- A)** Double safety platform with gas spring operation.
- B)** Safety counterweight platform with cable and pulley operation.

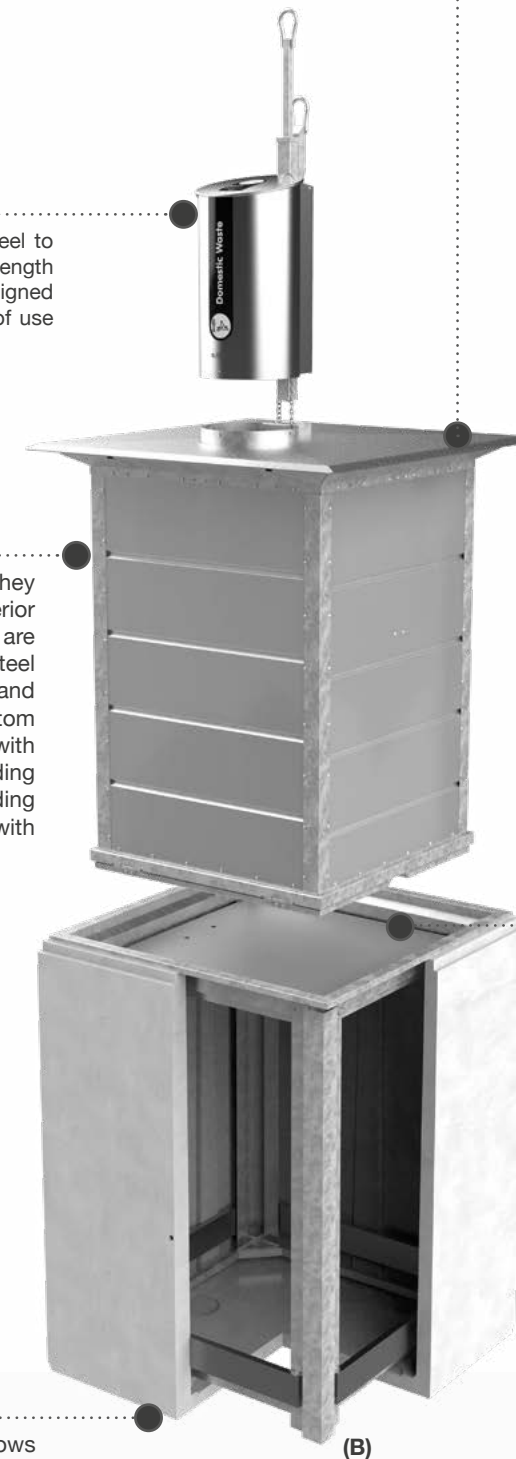

Collection system

The collection system is designed to be handled conveniently by a single operator. Different types of fittings and hooks are applied to the intake column depending on the system on the truck crane.

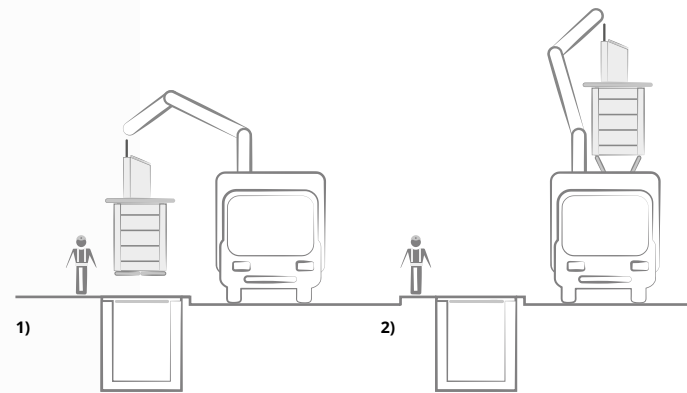

Collection Mushroom / Double-Hook

The container has a bottom opening (3m³, 4 m³ or 5m³ capacity) with two doors with leachate retention basins and is adapted for top loading trucks with crane prepared for double-hook or "Kinshofer" mushroom type of fitting.



1

- 1) Movement of the crane and coupling in the hooks / mushroom existing in the container.
- 2) Lifting the container from inside the bunker and automatically opening of the bottom.

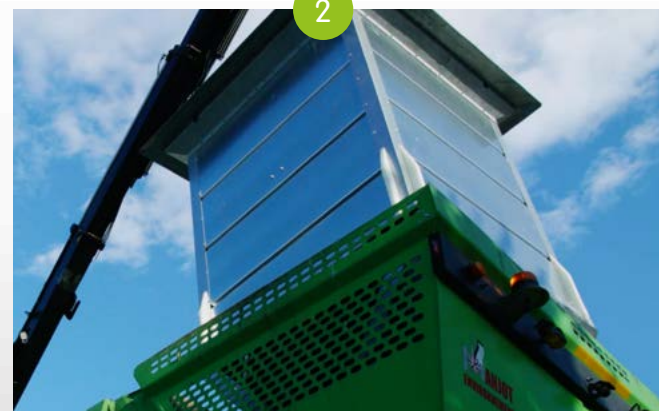

2



1

Collection Palpeur Top Collection

The container has a bottom opening (3m³, 4 m³ or 5m³ capacity) with a door with a leachate retention basin and is adapted for top loading trucks with a crane prepared for single-hook fitting and with a "palpeur" pedal for bottom opening. The bottom can be opened by impact or manually by steel cable.

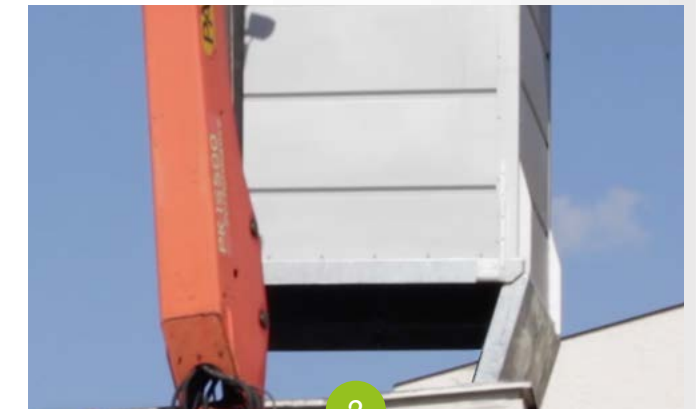

2

Collection Bilateral Top Collection

The container has a bottom opening (3m³, 4 m³ or 5m³ capacity) with two doors with leachate retention basin and is adapted for top loading trucks with automatic crane controlled inside the truck cab. The container is equipped with mushroom or F90 fitting.

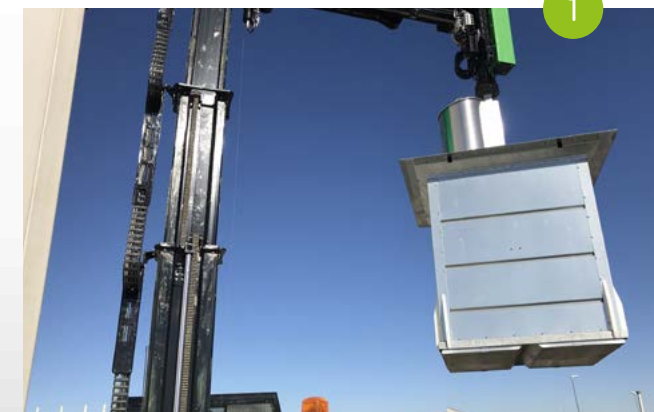

1

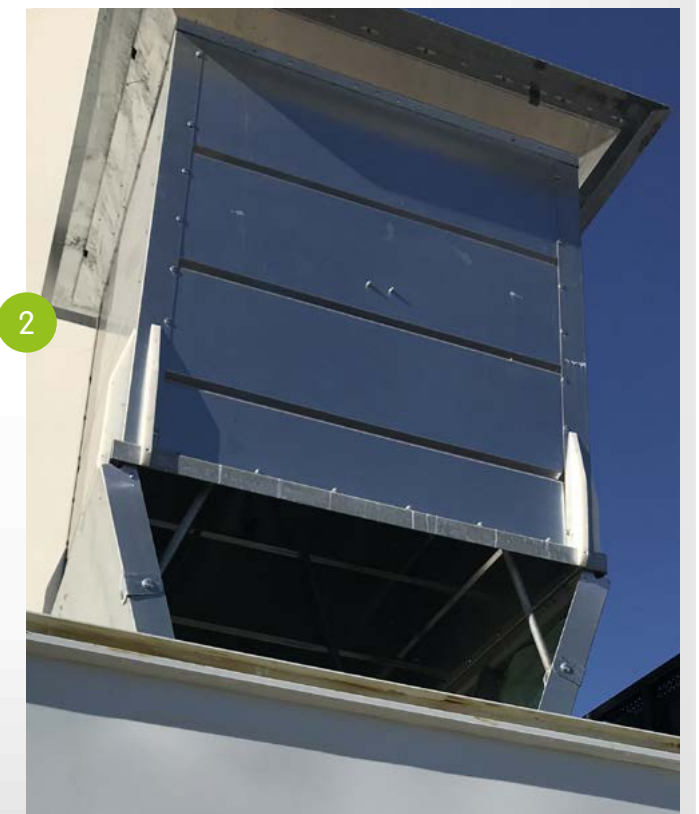

2

Simple to Install, Collect and Use

Sotkon's Apto system was designed having in mind ergonomics, ease of use, hygiene and safety.

1) Simple to Install

The Apto system allows easy adaptation to the characteristics of the installation terrain and can be integrated in all urban areas, especially in areas with high pedestrian traffic. It is extremely easy to overcome all barriers created by underground cables and other infrastructures.

2) Easy to Collect

The adaptation to the different collection types (single-hook, double-hook, Mushroom, or F90) makes the Apto system simple to operate by a single operator.

3) Simple to use

The attractive design and ease of use of our intake columns encourage the public to use the equipment and can be enhanced with access control for PAYT systems, which increase waste separation rates. Sotkon systems encourage good environmental practices and better waste separation, thus contributing to increased recycling.

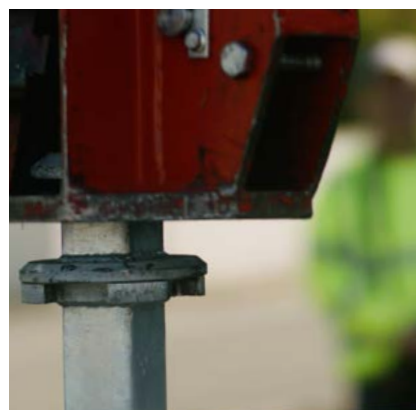

Technical Drawings (Assembly)

Capacity	A	B	C	D
3/4M³	1750	2750	1950	1950
5M³	2600	3600	1950	1950

Units in mm (approximate values).
These dimensions are not suitable for civil construction.

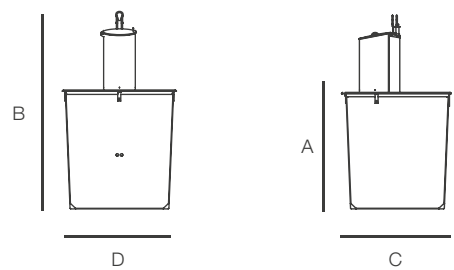

Intake Columns



Ikon



Drop



Diamond



Wido



Max



Max Double Drum



Orion



Diamond Konik



The Sotkis system is a system for monitoring and managing the processes involved in waste disposal and collection. Associated with the Sotkis management system, Sotkon has developed equipment that enables the implementation of the "pay-as-you-throw", or PAYT, principle for fairer taxation on waste disposal.

www.sotkis.com

PAYT
Pay as you throw

Mobile APP
Available on Google play and the App Store

Level

Level Sensor



.Sensor

Access

Access Control



.Smart Tag/Card

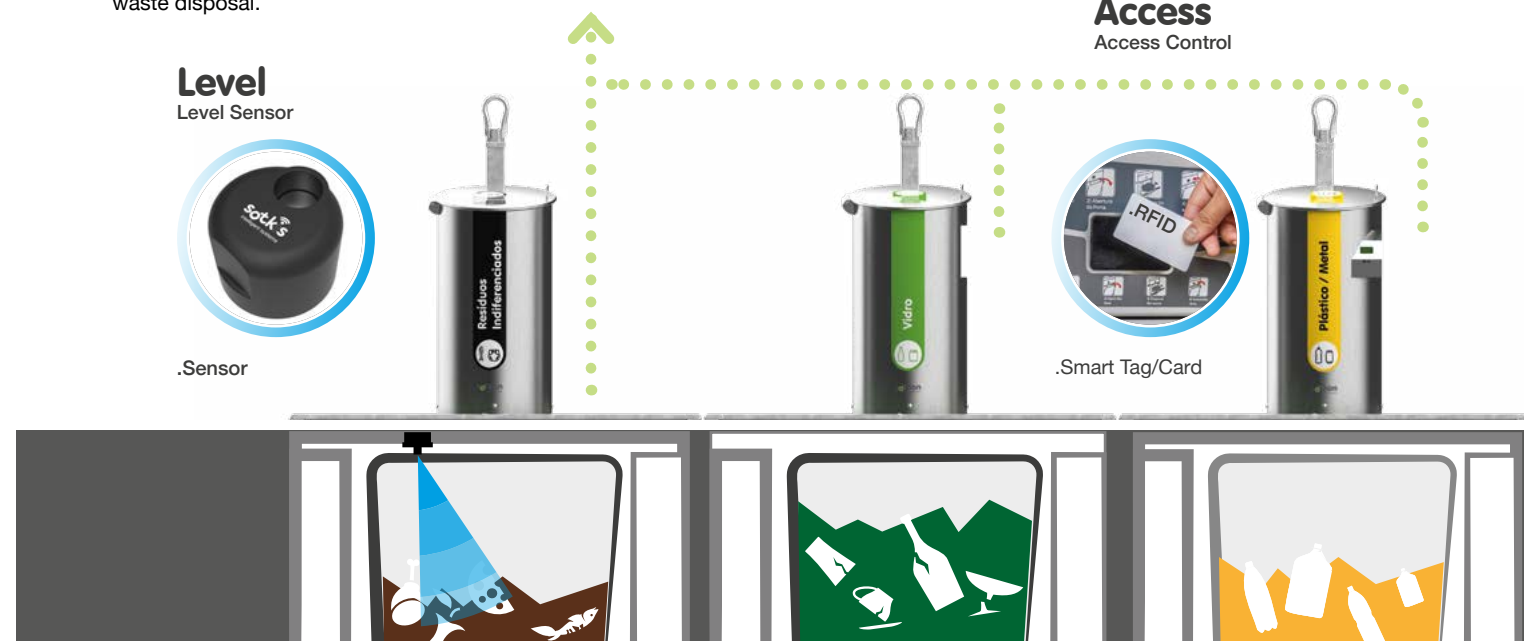



Find out more about this equipment here!



www.sotkon.com

v4.0522.EN



sotkon
waste systems

**Simple and
efficient.**



All the components are tested with TUV Rheinland supervision according to the standards EN13071-1 and EN13071-2 and European normative machine 2006/42/CE.

Worldwide Patented System

